



Intelligent Refractor
RT-6100



THE ART OF EYE CARE



Elevated refraction



The RT-6100, a breakthrough refractor from NIDEK, will inspire you in unequalled refraction workflow. It is designed to help operators demonstrate creativity without compromising patient comfort.

The combination of a streamlined refractor head and user-friendly control console allows exceptionally precise and efficient examinations. Enhanced data communication functions strengthen the seamless network in diverse environments.

Integration of the RT-6100 into a refraction workstation COS-6100 with other NIDEK products, such as objective refraction devices, chart presenting devices, and lensmeters, creates a smoothly combined and efficient total eye examination solution.

Discover the power of a versatile and comprehensive refraction system that fulfills your present, and future needs - now.

Superior quality crafted into every detail

Sleek form

In pursuit of a superior experience for both patient and operator, the RT-6100 employs a honed ergonomic design. The streamlined shape makes a sophisticated impression.

Elegance in motion

Extremely smooth, quiet and speedy lens changes ensure reliable and comfortable measurement without distraction.

Accurate results

The clear blue LED forehead rest indicator helps to ensure correct patient position. A wide visual field of 40 degrees also provides greater visibility for patients, to consistently obtain accurate measurements.



10.4-inch color LCD touch screen

The 10.4-inch color LCD touch screen displays a great deal of information including near chart images, refraction diagrams, eye diagram, and visual images as viewed through eyes with pathology.

Reversible flip-display

The display can be flipped to the patient's side when used in near vision check or patient education.

Toggle dial

Measurement values are easily changed by turning the toggle dial. The button in the center of the dial allows operators to quickly switch between sphere, cylinder, and axis using only one hand. A logically arranged keypad enables intuitive operation while remaining engaged with every patient.





Robust exams with user-friendly features

Easy comparison

Patients can easily compare their vision with five different refraction conditions.* This comparison enables you to make informed decisions during patient consultation and determine a precise final prescription.

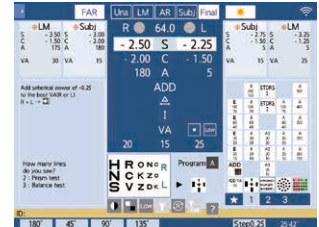

Cross cylinder test

Cylinder power and axis can be adjusted easily with the touch of a button. Auto cross cylinder function helps patients to compare two charts simultaneously.

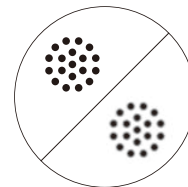

Auto cross cylinder

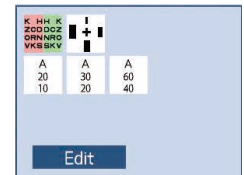

Favorite chart lists

Favorite charts

If you bookmark the frequently used charts, you can rapidly select them later and further improve practice efficiencies.

Seven refraction programs

Customize chart and auxiliary lens settings according to your preferred refraction sequence, allowing you to increase efficiency while dedicating more time for a thorough refraction. The binocular open refraction program uses fogging and takes measurements under more natural viewing conditions for the patient.



Operation message

The refraction operating procedure is displayed on the operator's screen based on the chart selected, ensuring a smooth refraction process.

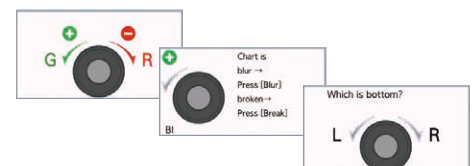

Seamless near vision test

During the near vision test, PD and convergence are adjusted automatically. A bright, energy efficient white LED illuminates the near chart.



*Unaided, current glasses, objective refraction, subjective refraction, and final prescription

Premium consultation features for advanced assessments

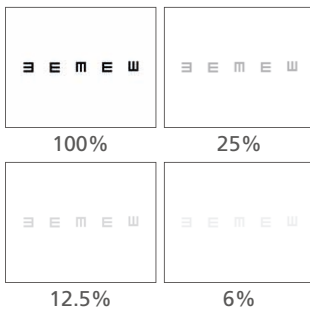

Contrast, black and white inversion functions*1

The contrast test confirms the visual function with contrast sensitivity of patients who have undergone cataract or refractive surgery. For low vision patients, the black-white invertible VA chart is also available.*2



Night mode*1

Some patients have different sphere, cylinder, and axis values between their day and night pupils. Night mode examines night-time visual acuity under low light conditions to correspond these patients.



Final Fit for the best fit prescription

The RT-6100 incorporates Final Fit, the adjusted power calculation program, to help find the most comfortable prescription for each patient to suit their needs.

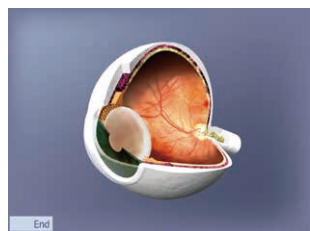

Clear vision range check

Clear vision range check supports a comprehensive explanation to patients. Based on measured values, it gives the patients a visual aid in a graphical form to demonstrate the range of clear vision with their correction in place.

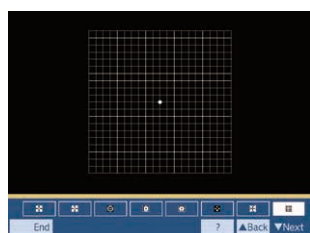

Displaying images

The images in the SD memory card can be displayed on the control console screen. A list of images is displayed as thumbnails for easy management.

Amsler grid drawing

Patients can draw their vision patterns on screen with a touch pen to depict how they visualize the chart.

*1 The functions are available when connected to the system chart SC or space saving chart SSC. Available SSC types are limited.

*2 VA value is for reference.

Superior examinations and consultations with the OPD-Scan III or OPD-Scan III VS

Enhanced objective refraction with the OPD-Scan III series

Auto refractometer / Keratometer are adequate for prescribing habitual eyeglasses or contact lenses. However, the OPD-Scan III series incorporates wavefront aberrometry / topography, allowing you to perform enhanced diagnostics facilitating the introduction of value-added optical products/features.



Product/model:
REFRACTIVE POWER /
CORNEAL ANALYZER OPD-Scan III

Day and night prescriptions

Based on day and night data from wavefront aberrometry acquired with the OPD-Scan III series, the RT-6100 can seamlessly perform refractions under day and night viewing conditions – allowing patients to understand the benefits of an additional prescription exclusively for nighttime.



Simplified data transfer

NIDEK products work together to enhance productivity and communication in your practice. Seamless data transfer increases examination efficiency while maintaining high-quality performance. The RT-6100 supports LAN and WLAN. With the optional data storage device Memory Box MEM-200, serial devices can also be connected. Easy data output to external PC allows for seamless data management.

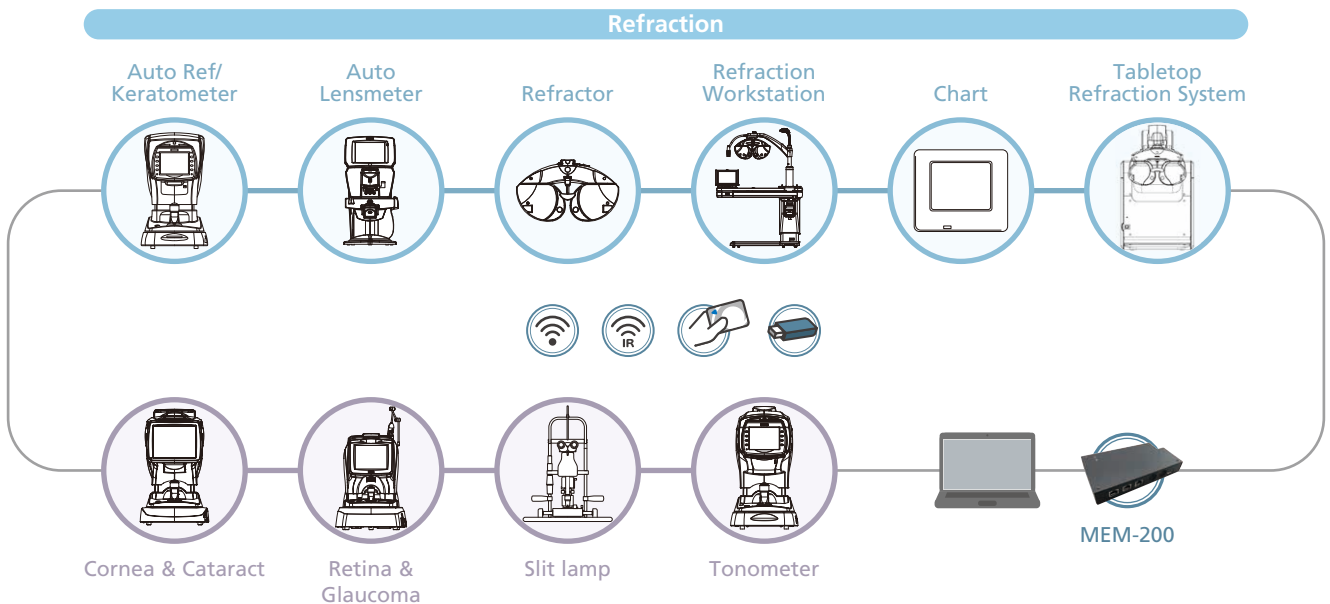

Seamless integration with the NIDEK charts

With our comprehensive product lineup, we offer a variety of combinations to meet your needs. Increase your examination efficiencies and benefit from synergies by combining optimal products for your practice with your expertise.

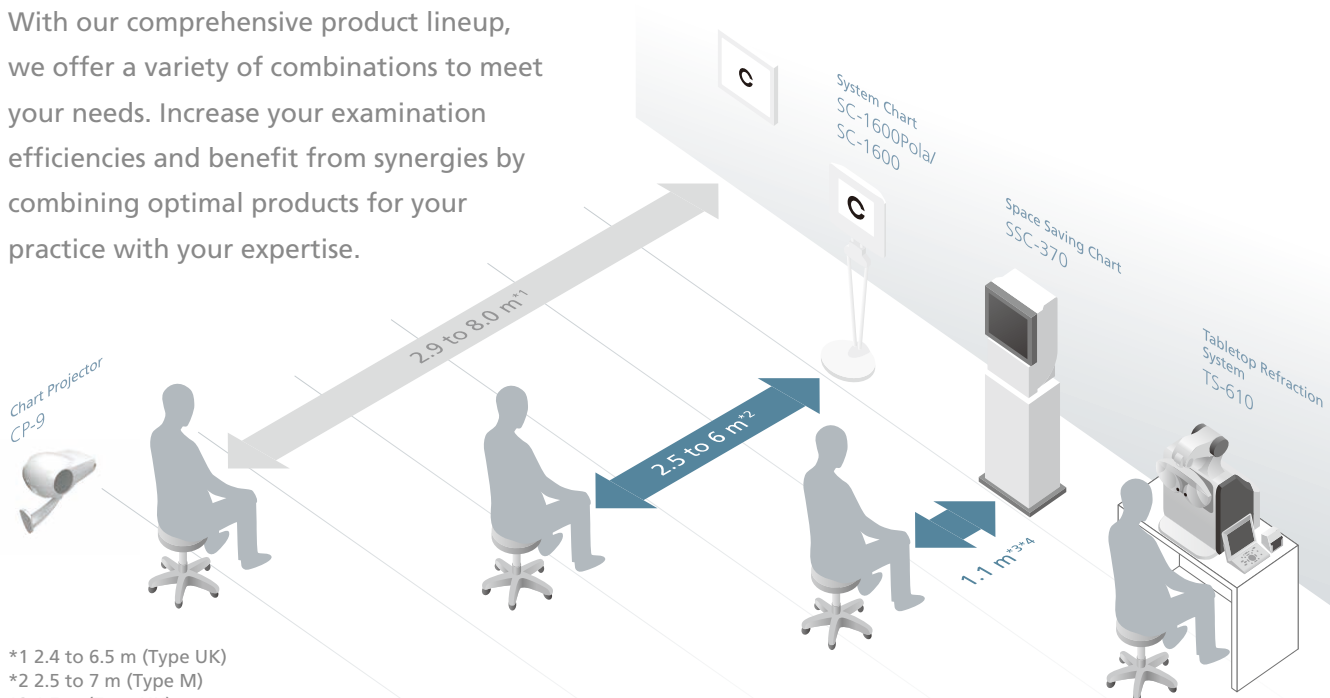

*1 2.4 to 6.5 m (Type UK)
 *2 2.5 to 7 m (Type M)
 *3 1.5 m (Type UK)
 *4 Type T and Type UK have optional installation distances available.

Selectable user interface

The operator can choose between using the standard control console or a computer/tablet by using CB for Windows.*¹ Explore the possibilities.



Stay connected with the patients from a remote location.*²

NIDEK CB for Windows will improve the flexibility and efficiency of your operation.

CB for Windows is an optional control software for the Intelligent Refractor RT-6100 and the Tabletop Refraction System TS-610.

This software delivers the comprehensive examination capabilities of the existing control console through a Windows computer.

Experience the advantage of new possibilities provided by NIDEK.

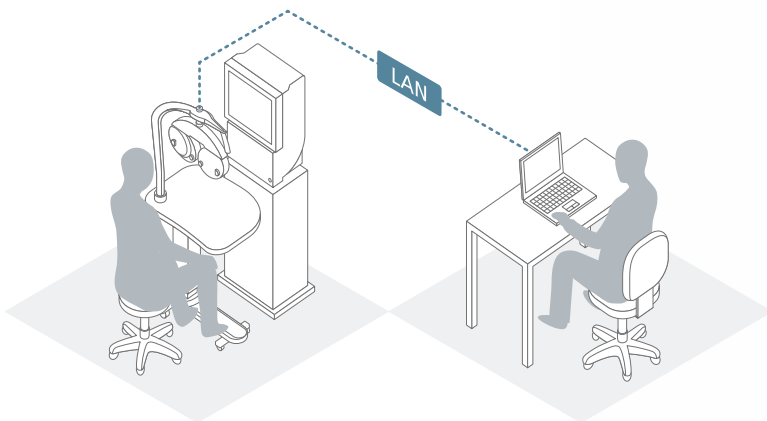

This configuration is just an example.



*¹ Control console and Windows computer/tablet cannot be used/connected simultaneously.

*² Operation from a different location can be performed by remote operation of the computer.

NIDEK does not include or provide the functions or software necessary for remote communications.

The working environment and the specifications/performance of individual computers may impact software usability.

Build your customized workstation

The RT-6100 can be integrated into the NIDEK COS-6100 refraction workstation with other NIDEK products including objective devices, LCD chart devices, and lensmeters. Increase your examination efficiencies and benefit from synergies by combining optimal products for your practice with your expertise.



Optimized combinations

The COS-6100 is designed to make your refraction experience more inspiring, enjoyable, and rewarding, by providing numerous instrument combinations from a broad product offering.

Motorized table with safety mechanism

The main table provides excellent stability with silent, effortless vertical adjustment.



Proven durable construction

The durable, practical design allows easy setup and creates comfortable examination space both for operator and patient. The simple but versatily designed workstations fit any space and aesthetically compliment NIDEK product designs for an attractive and functional addition to any facility.

Safety one-touch lock arm

The refractor head smoothly slides back and forth in an arc. An arm release/position lock button improves the stability and safety of every examination.



Drawers for trial lenses*

Drawers space facilitates and expedites the selection and storage of trial lenses.

*The trial lenses are not included or sold with the COS-6100.

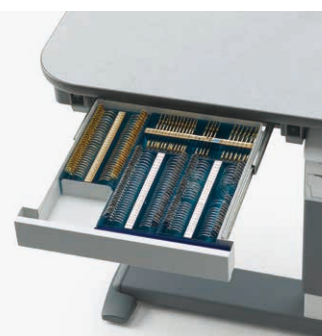



COS-6100 Table (ST-6100)

Complete performance packages

- All components of the refraction process
- Customizable optional accessories

Side table for space saving chart and lensmeter

Two-unit mounting tray for objective device and slit lamp

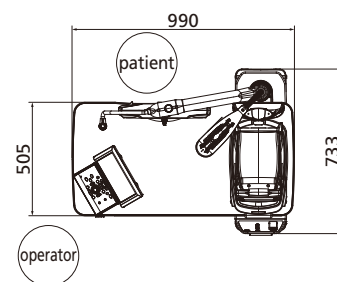
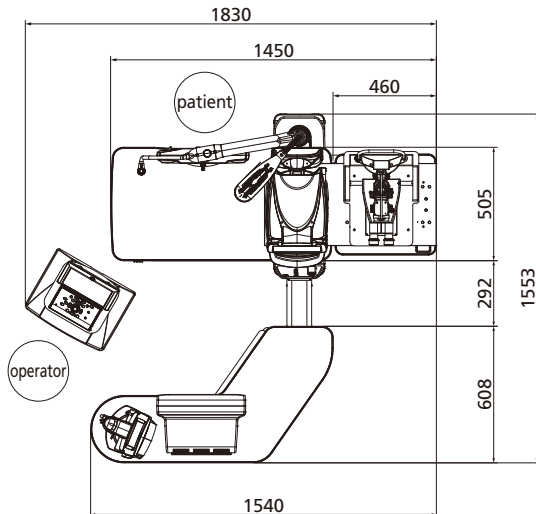

COS-6100 Table (ST-6100) Specifications

RT arm	Electromagnetic lock
Up-and-down of RT arm	Stroke 310 mm
Back-and-forth of RT arm	Stroke to patient side 230 mm
Power supply	100 to 120 V AC / 220 to 240 V AC, 50/60 Hz
Power consumption	600 VA (max, including RT and other optometry devices)
Standard accessories	Power cord, Fuse, Power cord for chart, Refractor head hanging bracket
Optional accessories	Side table R, Side table L, Two-unit mounting kit R, Two-unit mounting kit L, Conversion cable (for mounting OPD-Scan III), Takagi Slit Lamp one-unit mounting kit, MEM-200 mounting kit, SL-1800 mounting set (for two-unit mounting tray), SL-1800 mounting set (for one-unit mounting tray), AR-F/ARK-F mounting plate, OPD-Scan III mounting plate (for two-unit mounting tray), Manual RT mounting kit R, Manual RT mounting kit L, CP3B-19 kit, Tray for trial lenses

RT-6100 Specifications

Measurement range	
Sphere	-29.00 to +26.75 D (0.12/0.25/0.50 to 3.00 D increments) -19.00 to +16.50 D (cross cylinder test, prism test)
Cylinder	0.00 to ± 8.75 D (0.25/1.00/2.00/3.00 D increments)
Axis	0 to 180° (1°/5°/15° increments)
PD	48 to 80 mm (far mode) 50 to 74 mm (near working distance of 35 cm) 54 to 80 mm (far PD possible for 100% convergence)
Prism	0.00 to 20.00 Δ (0.1/0.5/2 Δ increments)
Auxiliary lenses	
Cross cylinder lens	± 0.25 , ± 0.50 , ± 0.25 D auto cross
Occluder	Available
Pinhole plate	$\phi 2.0$ mm
Red/green filter	Right eye: red, Left eye: green
PD check lens	Available
Polarizing filters	Right eye: 135° / Left eye: 45°, Right eye: 45° / Left eye: 135°
Fixed cross cylinder lens	± 0.50 D (fixed with the Axis set at 90°)
Spherical lenses for retinoscope	0/+1.5/+2.0 D (selectable by setting)
Red maddox rod	Right eye: horizontal, Left eye: vertical
Dissociation prism	Right eye: 6 Δ BU / Left eye: 10 Δ BI
Dissociation prism for binocular balance*1	Right eye: 3 to 10 Δ BD / Left eye: 3 to 10 Δ BU
Dissociation prism for horizontal phoria*1	Right eye: 3 to 10 Δ BU / Left eye: 3 to 10 Δ BD
Dissociation prism for vertical phoria*1	Right eye: 5 to 15 Δ BI / Left eye: 5 to 15 Δ BI
Fixed cross cylinder & dissociation prism for horizontal phoria*1	Right eye: 3 to 10 Δ BU / Left eye: 3 to 10 Δ BD
Binocular open fogging	0.00 to +9.00 D
Visual field	40° (VD = 12 mm), 39° (VD = 13.75 mm)
Refraction distance for near vision	350 to 700 mm (50 mm increments)
Forehead rest adjustment	25 \pm 2 mm
Vertex distance marking	12, 13.75, 16, 18, 20 mm
Level adjustment	$\pm 2.5^\circ$
Display	10.4-inch color LCD
Printer	High speed line printer
Interface	RS-232C: 1 port for connection with chart presenting device USB: 1 port LAN: 3 ports Wireless LAN (WLAN)*2 (optional)
Power supply	100 to 240 V AC, 50/60 Hz
Power consumption	90 VA
Dimensions/mass	
Refractor head	408 (W) x 107 (D) x 277 (H) mm / 3.2 kg 16.1 (W) x 4.2 (D) x 10.9 (H)" / 7.1 lbs.
Control console	260 (W) x 230 (D) x 207 (H) mm / 2.1 kg 10.2 (W) x 9.1 (D) x 8.1 (H)" / 4.6 lbs.
Relay box	189 (W) x 221 (D) x 73 (H) mm / 1.4 kg 7.4 (W) x 8.7 (D) x 2.9 (H)" / 3.1 lbs.
Printer	101 (W) x 86 (D) x 121 (H) mm / 0.6 kg 4.0 (W) x 3.4 (D) x 4.8 (H)" / 1.3 lbs.
Standard accessories	Face shield, Forehead rest, Stylus pen, Printer paper, Dust cover, Near point chart, Near point rod, Knob, Power cord, Communication cable
Optional accessories	Eye Care card, Infrared communication unit, Refractor head tilt unit, Control console stand, Wireless LAN module, Memory box, Space Saving Chart SSC-100, Near point rod, Relay box - control console cable 10 m, LAN cable, RT-6100 CB for Windows

*1 Changeable in increments of 0.5 Δ for monocular measurement

*2 Only for the countries (regions) certified by the Radio Law

Product/model name: REFRACTOR RT-6100

System Table ST-6100

CB for Windows is optional for the Intelligent Refractor RT-6100 and the Tabletop Refraction System TS-610. CB for Windows does not work without these devices.

Brochure and listed features of the devices are intended for non-US practitioners.

The availability of products differs from country to country depending on the status of approval.

Specifications may vary depending on circumstances in each country.

Specifications and design are subject to change without notice.

The computer and tablet described in this brochure are not provided by NIDEK.

Microsoft and Windows are registered trademarks or trademarks of Microsoft Corporation in the United States and other countries.

All LCD images are simulated.

